

UNIVERSAL 601

High performance brush cleaning and
deburring machine in modular design



WESERO Maschinenbau GmbH has been manufacturing brushing and mechanical treatment systems for over 20 years. The Industrial Division specializes in mechanical brushing, pickling, chemical treatment and cleaning systems for the Metal Finishing, Automotive, Aircraft and Lamination Industries. The Electronics Division provides surface finishing systems, chemical clean, ultrasonic clean and various high pressure systems to the producers of Printed Circuit Boards, Board Assembly and Semiconductor products.

The modular design of the Universal Series, made especially for the Electronics Sector, has given proven versatility to meet varying production requirements in combining brushing and cleaning modules built to match process requirements. The heavy duty Stainless Steel and chemical resistant polymer construction along with ease of maintenance and operation has made the Universal Series the number one choice of many electronics producers.

Standing behind our innovative designs we have placed a full 10 year warranty on our patented hydrodynamic bearing used on the cantilever brush arm of the Universal 601 and 751 brushing modules.

This cantilever design offers great benefit in brush change time and again adds to meeting various process requirements allowing rapid change of brush type or multiple use of systems for different processes. No longer does the brushing process have to be interrupted for long periods to true brushes for wear and exposing the system to excessive brush debris, brushes can be easily replaced and trued off line. (Approximately 1 minute removal/replacement time per brush).

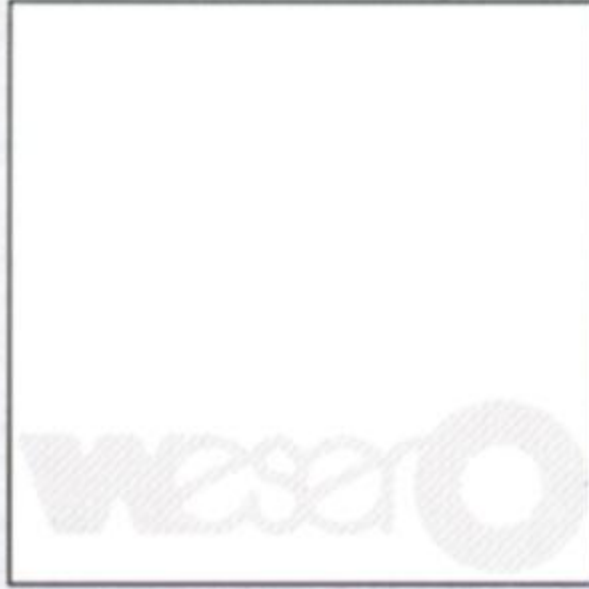

WESERO is constantly striving to increase the features of the Universal Series without adding to the cost or deteriorating from the proven high quality performance and construction of the systems. Recently the

U 601 (24 inch wide) and U 751 (30 inch wide) systems were introduced offering these upgrades:

All top conveyor rollers are driven and conveyor rollers have an increased diameter from 30 to 40 mm for accurate transport of thin materials

Conveyor rollers have bearings on both ends for smooth operation and extended rail life, while maintaining easy lift out removal

Module connect drive sections are tied with SSTL springs in place of O-rings

Spray bars have quick disconnect fittings of SSTL for ease of maintenance and cleaning

DC drive control for accurate and repeatable operation

The addition of material handling systems and closed-loop filtration creates a fully automated and environmentally sound process system to meet any production requirement.

The following pages highlight the system main features and modular variations available.

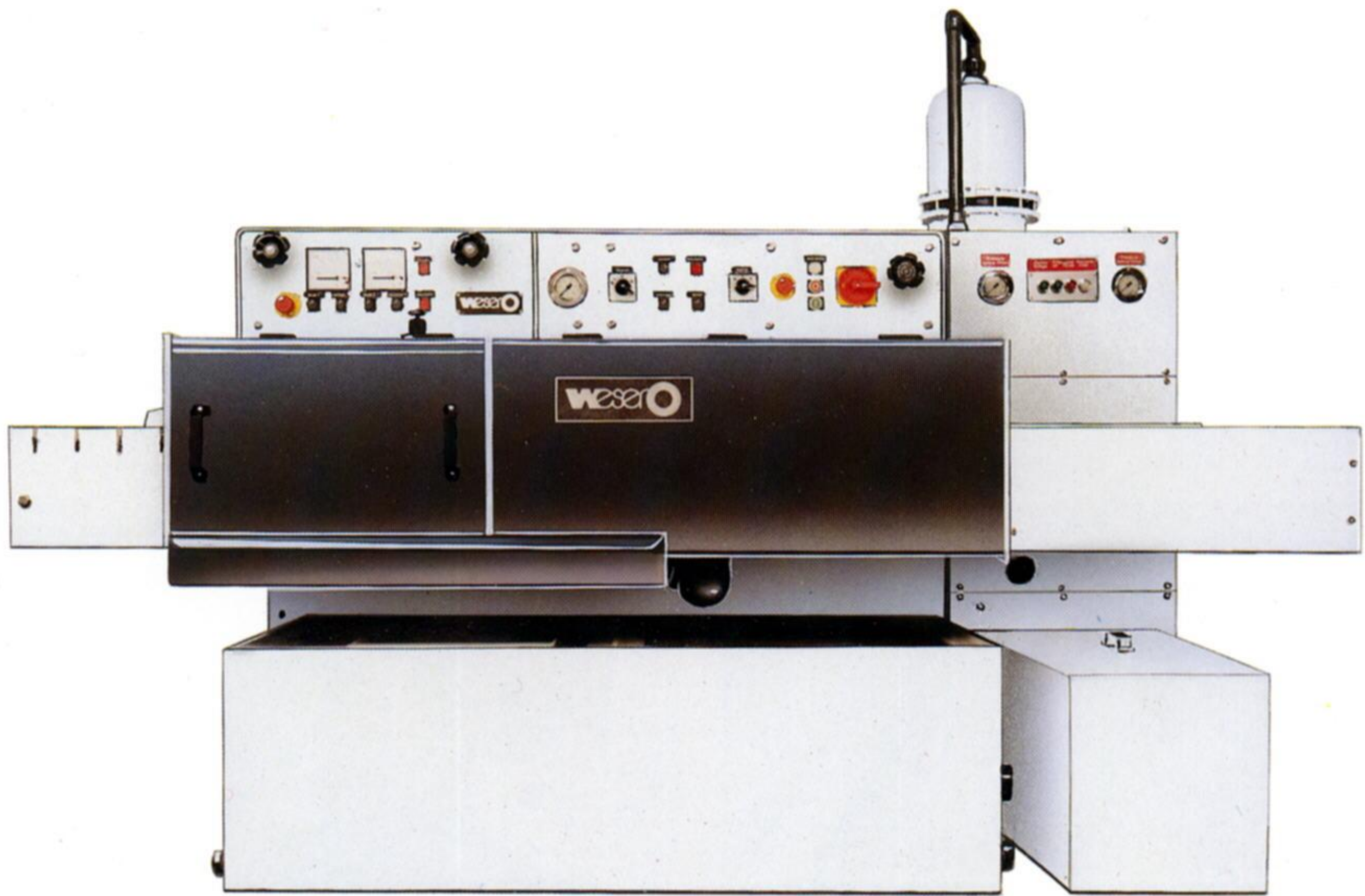

U 601/751 Base system - 12.5 - 24" brush section one top/one bottom, 12 - 24" rinse, heated drier, with airknife, shown optional Puomat-DE filter.

Standard Features - Benefits

Stainless steel main construction with chemical resistant polymer and torsion free welded steel framework	Long life - solid heavy duty construction
Cantilever construction brush shaft with patented hydrodynamic plane bearing	1 Minute brush change, 10 year warranty on cantilever bearing, low maintenance
1 top and 1 bottom 5" OD brush, selectable rotation, selectable oscillation at 280 cycles/min.	Larger brush to material flat area, greater process variety with selectable rotation and excellent surface finish with high speed oscillation
1 top and 1 bottom ceramic coated billy roller 3.4" OD, adjustable top billy	Larger brush to material flat area, long life - durable, eliminate curl on thin material
Transport thin material standard, top driven rollers, bearings on both sides of rollers	Transport .003" core material, long life - smooth operation
Modular design	Adapt system to process needs, double brush stations, ultrasonic, high pressure rinse, etc.
Full access rear maintenance covers	Maintenance ease, complete access
Standard 3 level heated dryer with high pressure suction blade	Dry panels at process speeds, thorough hole and edge drying

Options

Ultrasonic rinse (1500 W)	Filtration systems
High pressure rinse (350 - 700 PSI)	Microetch recovery/regeneration
Chemical rinses - Microetch	Material handling equipment
Cascade rinsing	Automatic brush adjustment
Custom designed features	Extended length dryer



U 601 - Quick disconnect SSTL spray bars

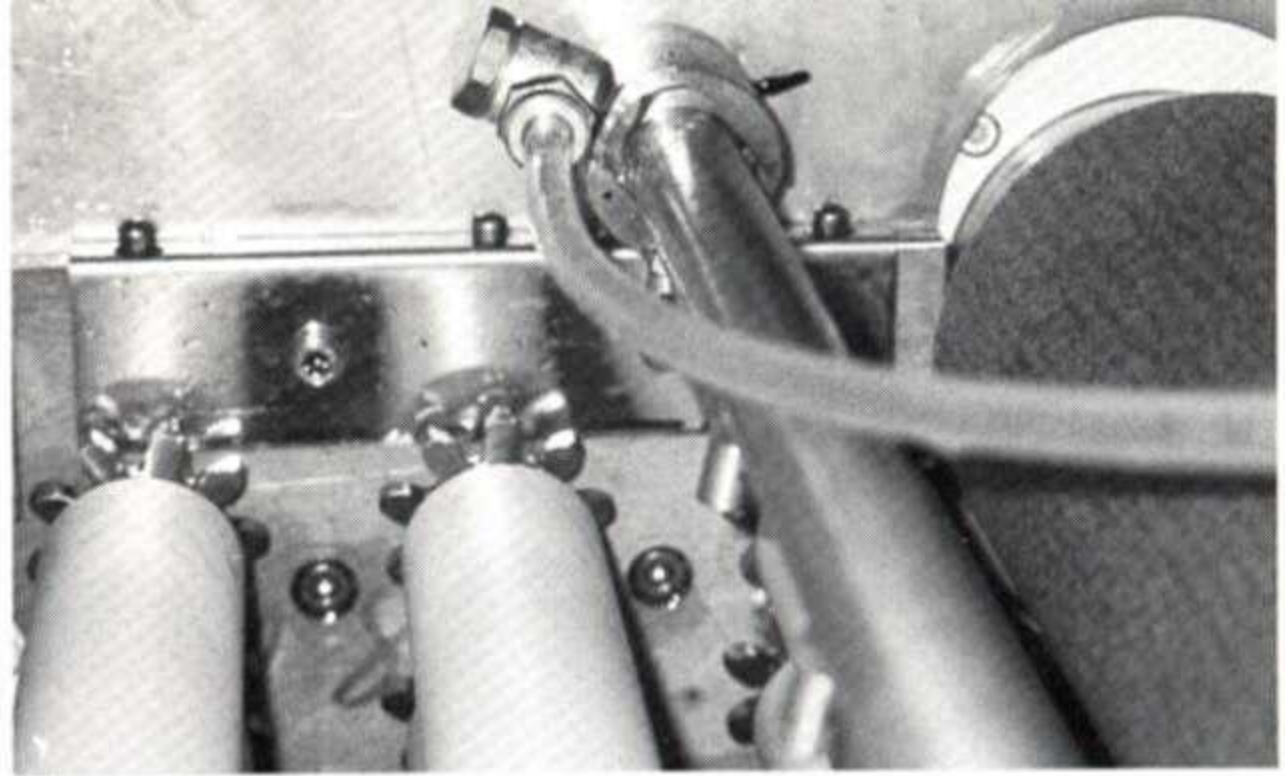

one minute brush remove

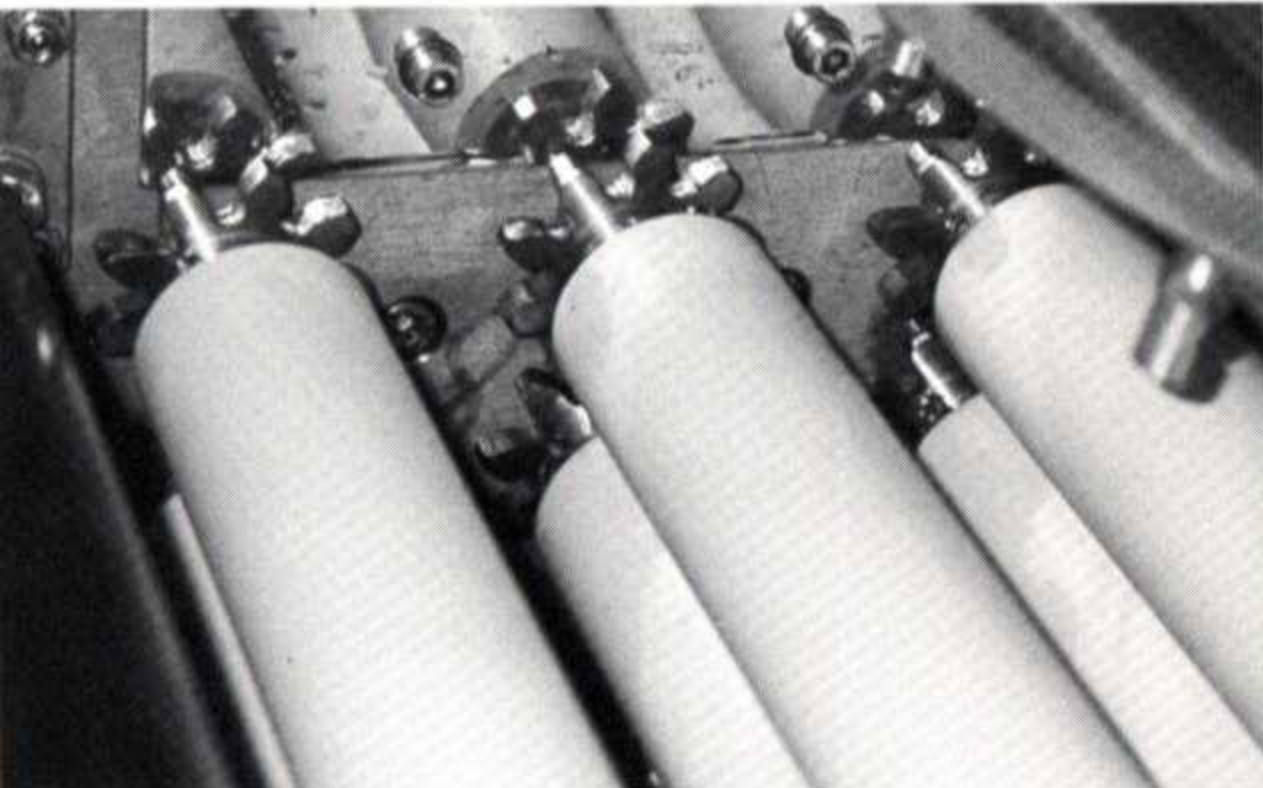

top driven roll
Special sealed roller bearings both sides

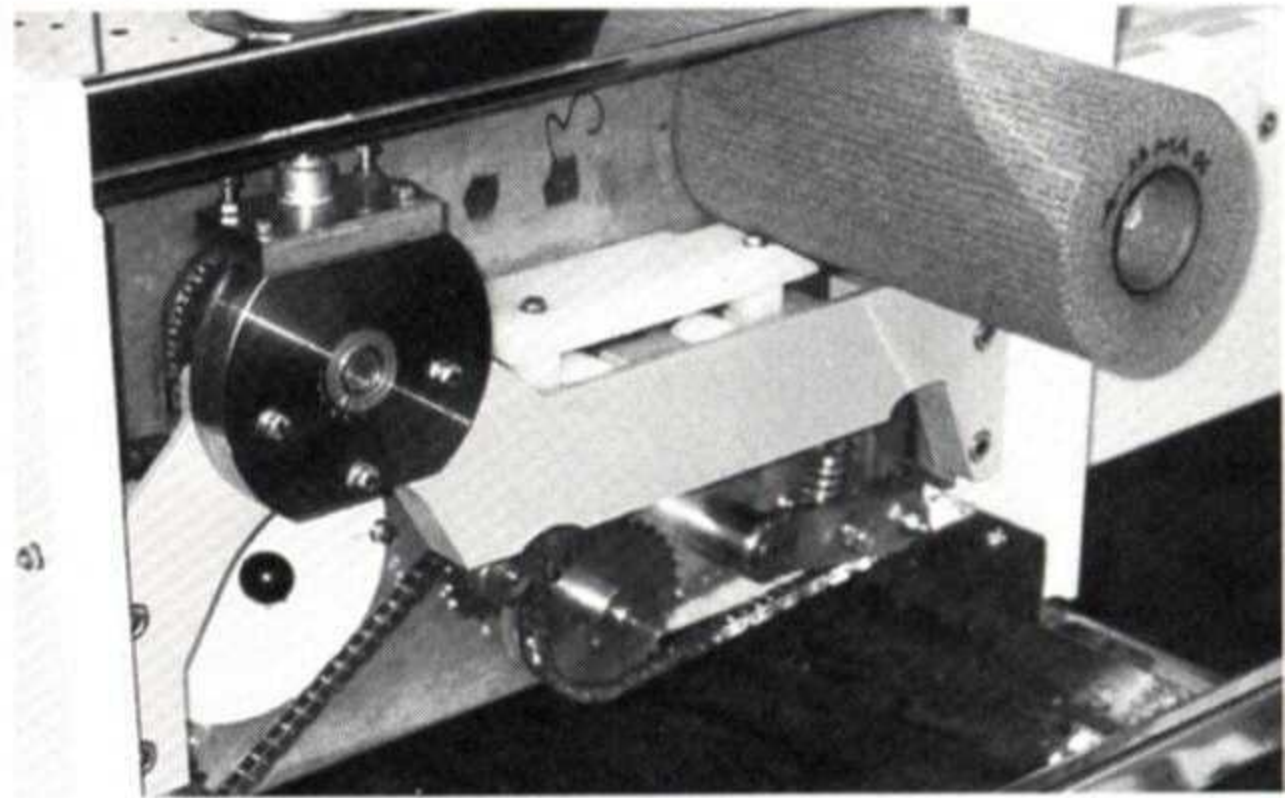

Adjustable top billy roller

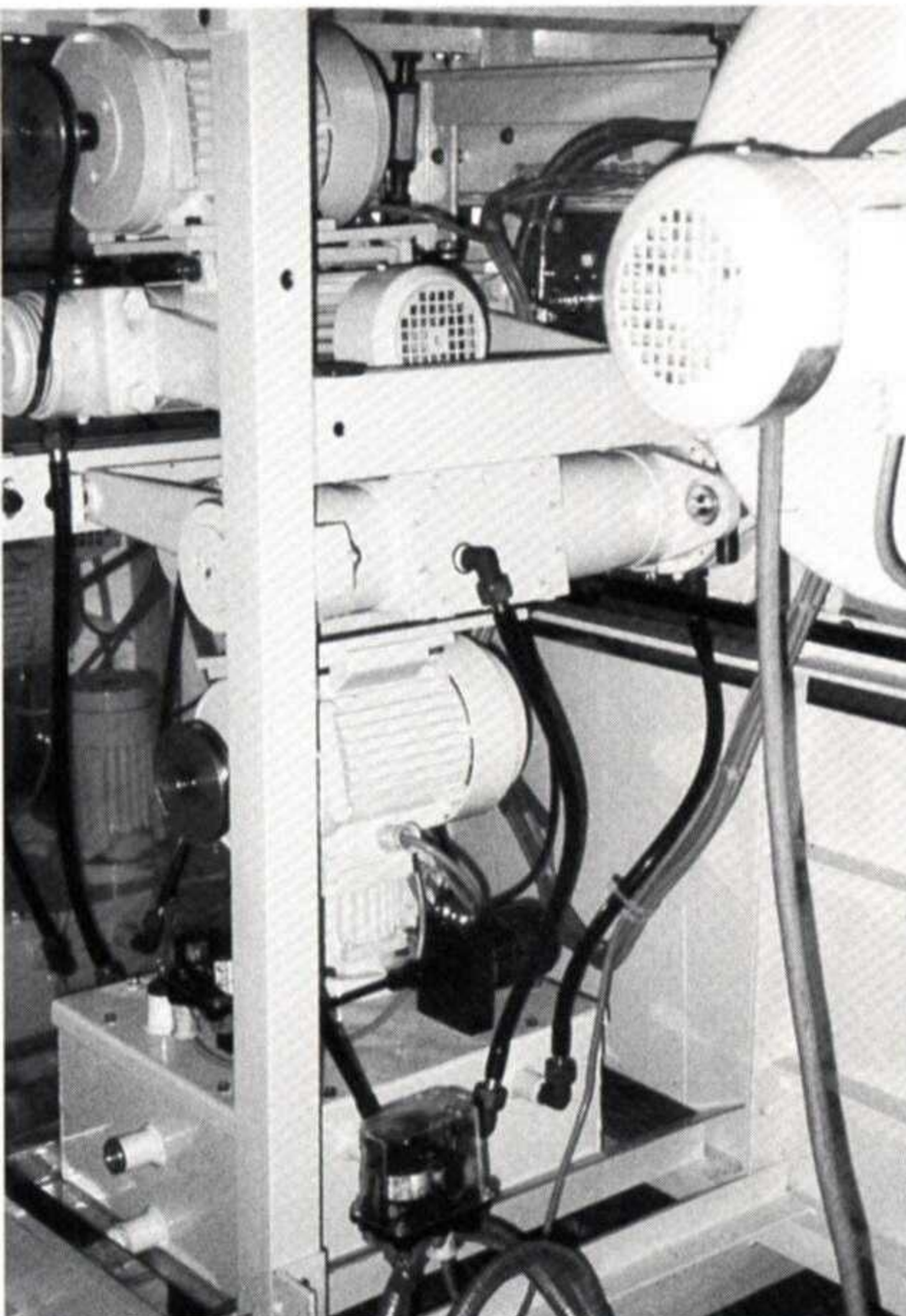

Back view: Brush section oscillating motors, oil lubrication system, dryer, suction blower

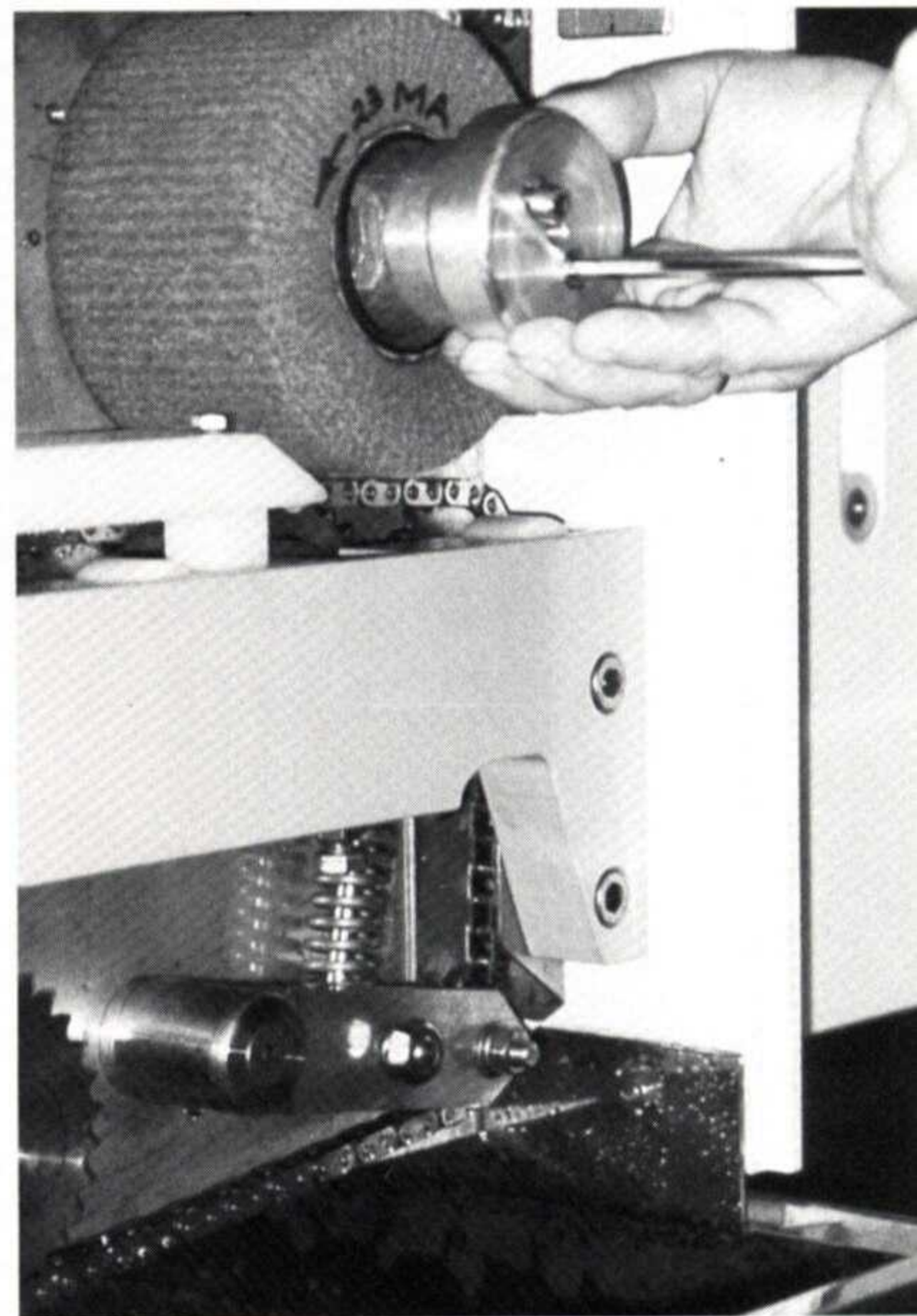

heavy duty isolated chain drive

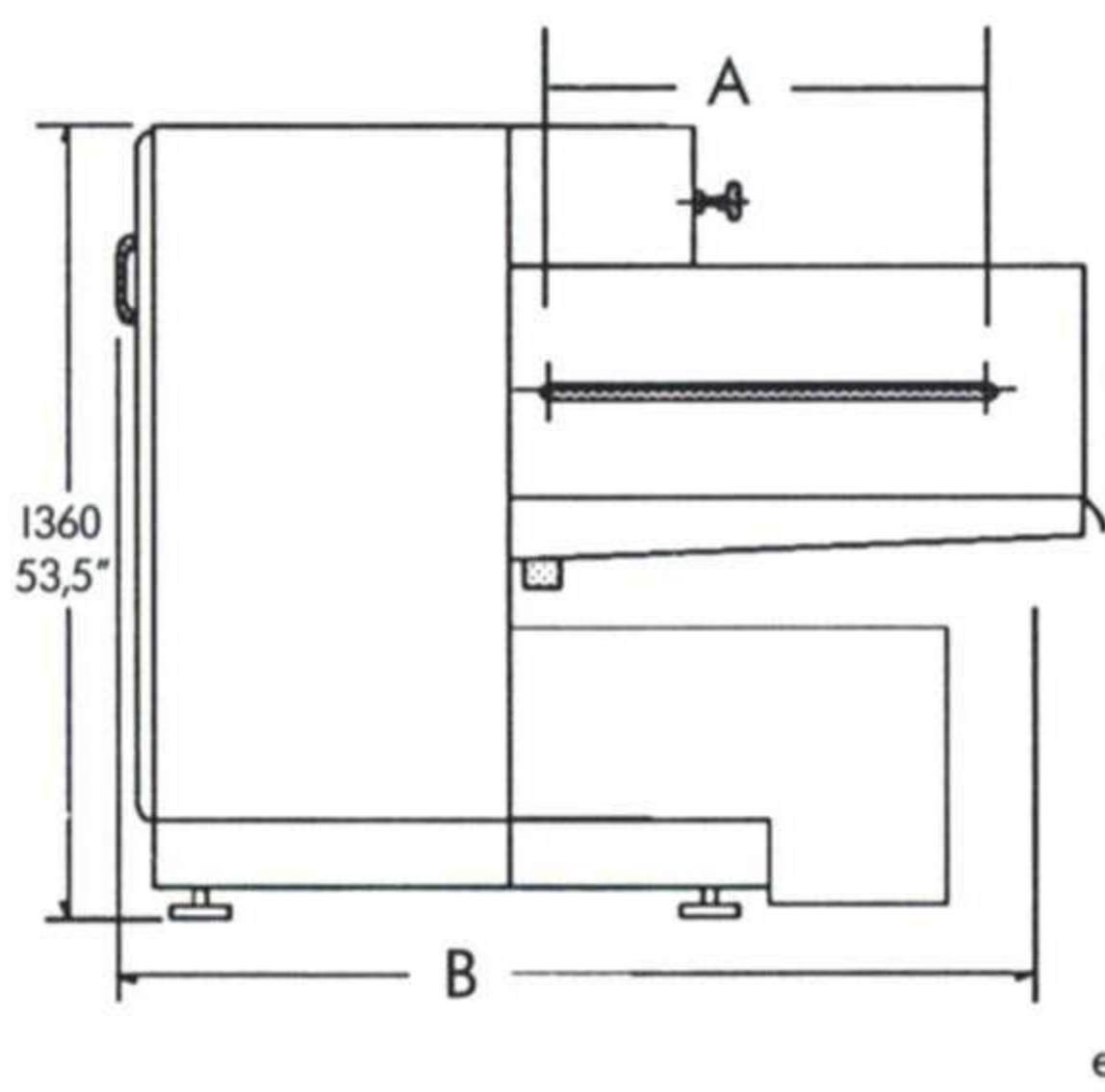
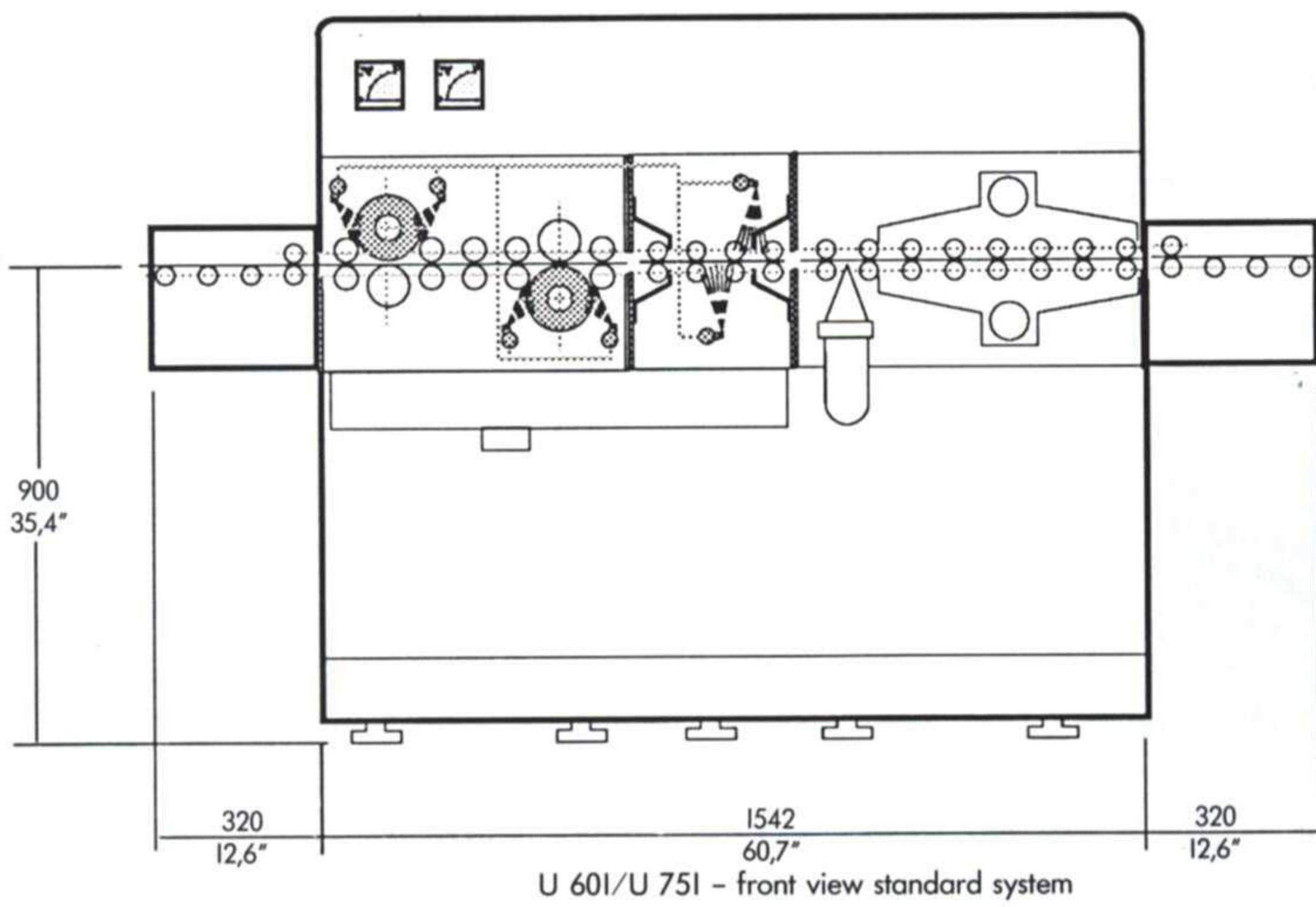

- A U 60I - 24" (650 mm)
- U 171 - 30" (750 mm)
- B U 60I - 61" (1550 mm)
- U 75I - 67" (1700 mm)

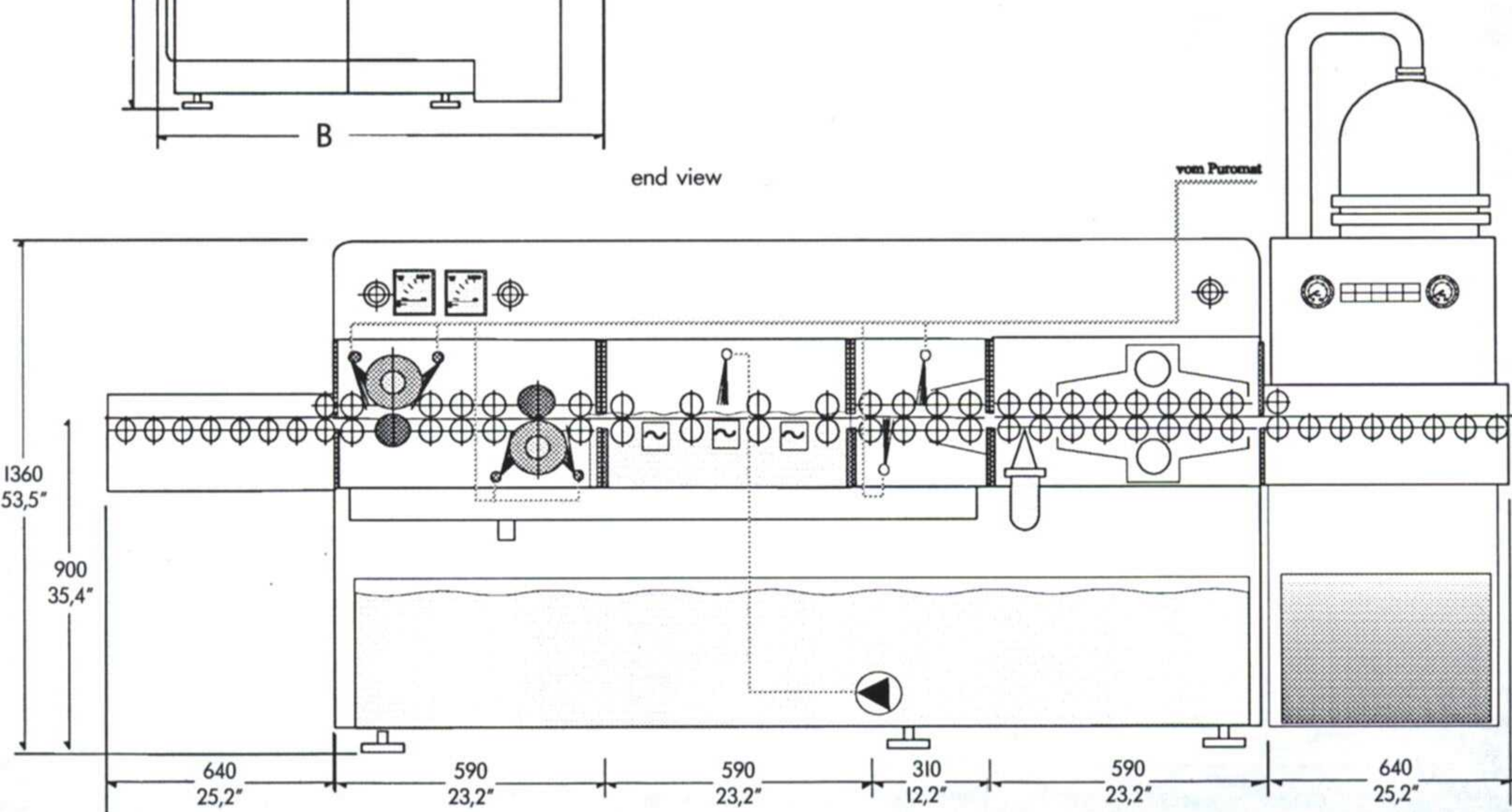

U 60I/75I with: input, brush, ultrasonic, high pressure rinse and dry section with output. Puromat fine copper DE filter system

Typical U 60I/75I ancilliary modules

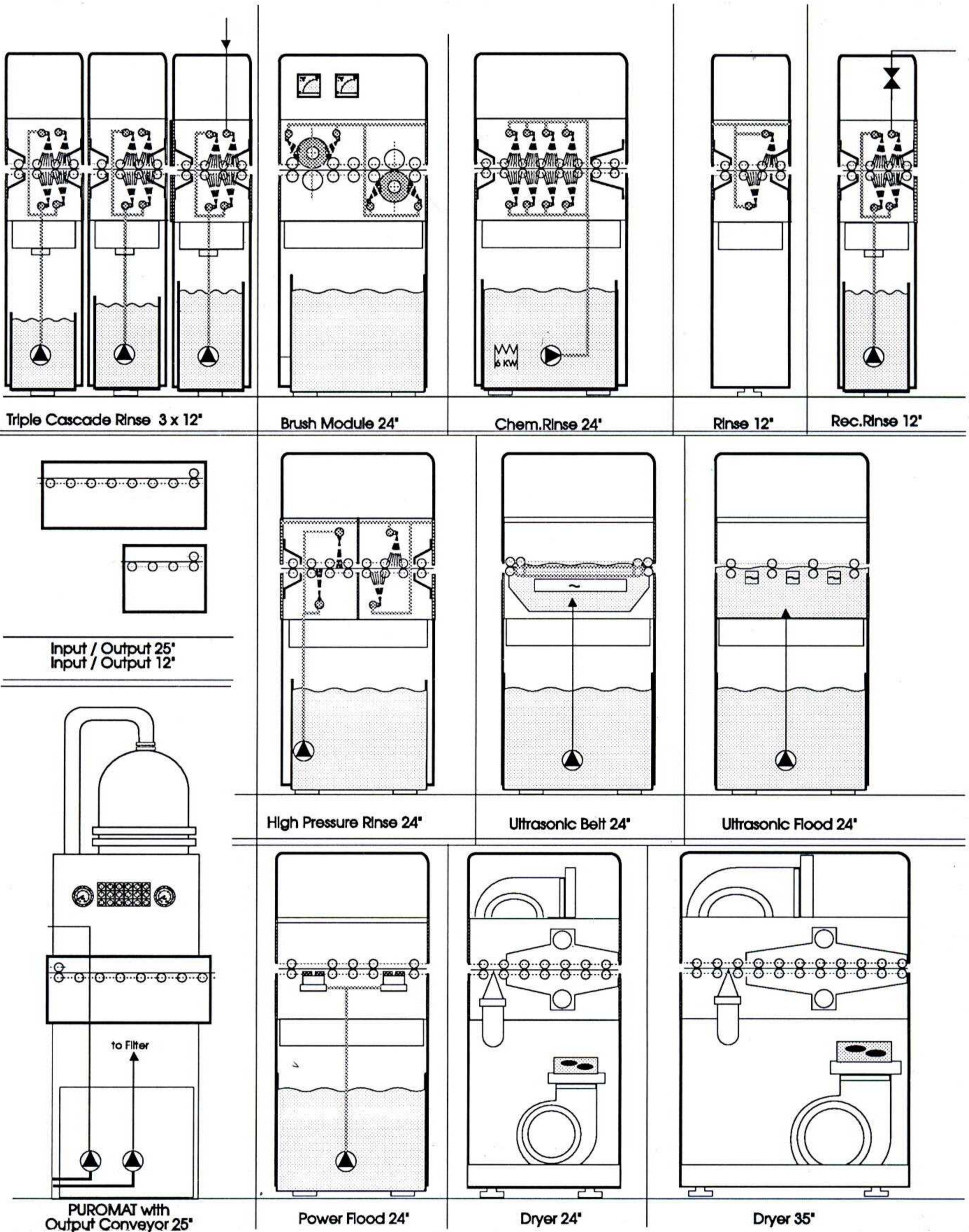

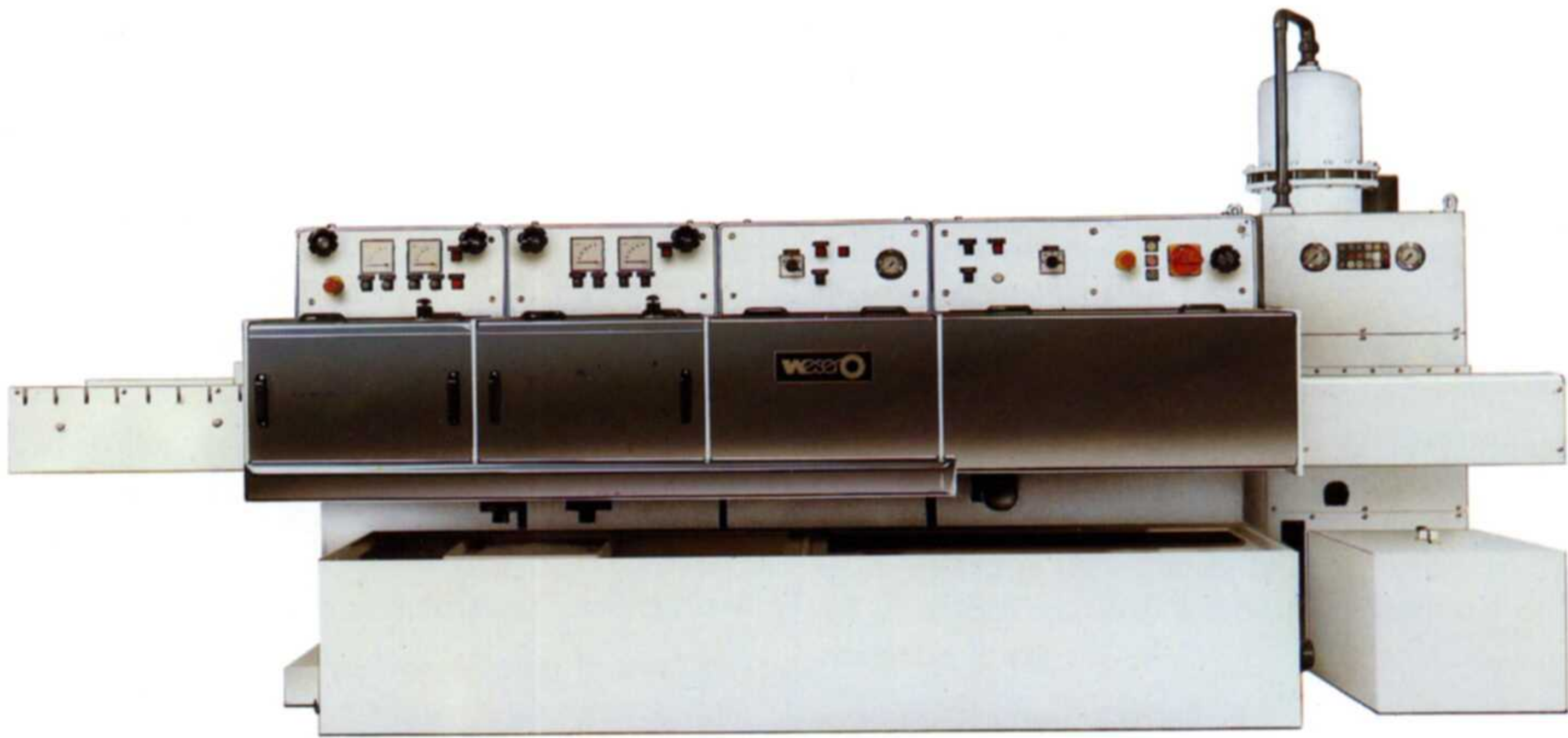

Basic model with second brush-module, ultrasonic and high pressure rinse for optimum deburring performance

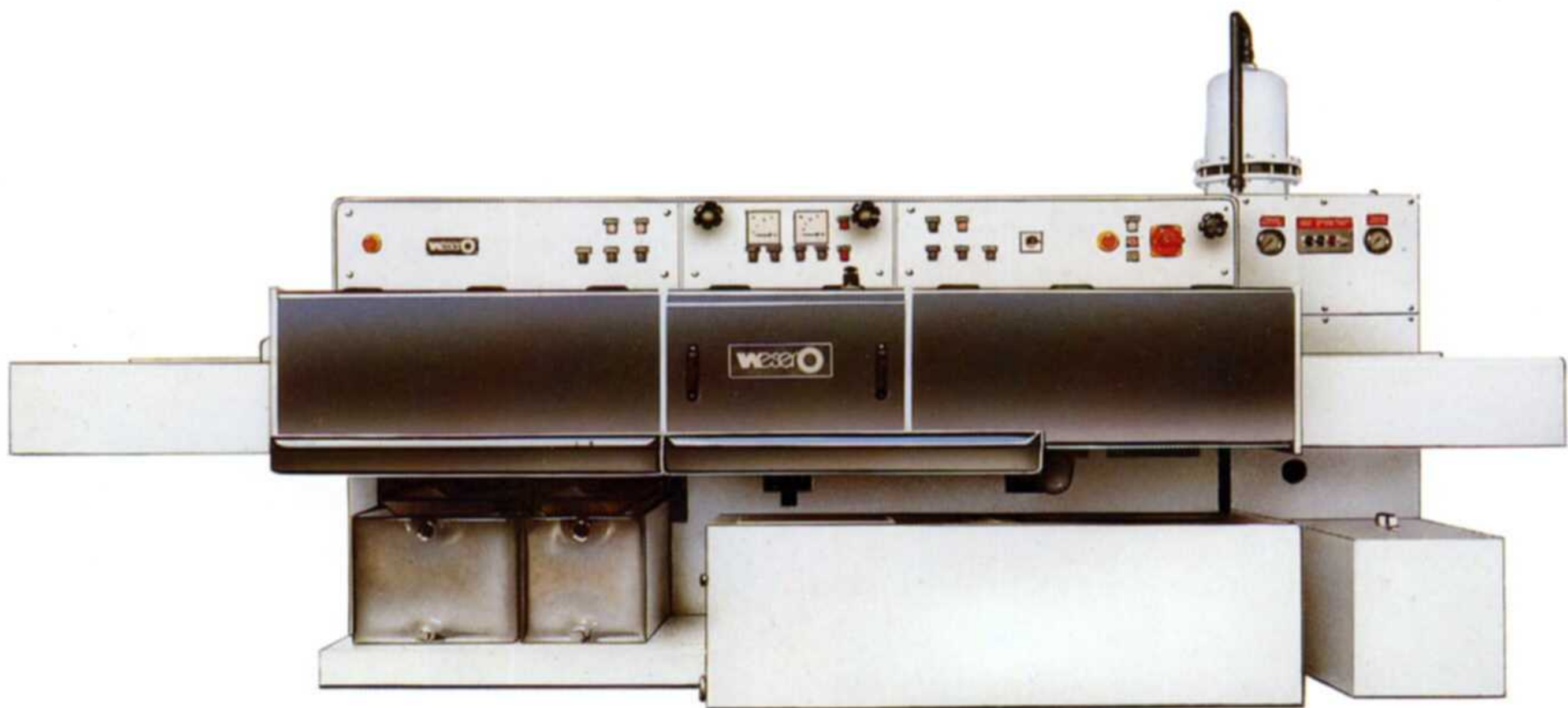

Basic module with pre-selectable chemical deoxidation and/or degreasing zone with recirculating rinse

Brushing – Microetch Versus Pumice



With new brush roller types and appropriate brushing machine configurations, copper surfaces are produced which were previously typically achieved by blasting with pumice powder or quartz powder.

Brush rollers made of ultra fine non-woven bonded abrasives installed on a WESERO U 60I system followed by a 24 inch microetch chamber and appropriate rinse and dry yield a matte copper surface with a peak to peak height in the range of 2.4 to 2.6 micron. These are optimum conditions for good adhesion.

The main benefit of the ultra fine bonded brush as compared to conventional brushes are:

- Less surface roughness (peak to valley height)

- An improved micro roughness (more grooves per unit of surface area)

- Increased surface area

- Cause less elongation

The design of the U 60I with 5" OD brushes against 3.4" billy rollers, adjustable top billy for elimination of curl on thin material and the precision brush pressure controls make optimum use of the ultra fine brush rollers against the board surface.

Utilizing sulfuric peroxide microetch provides a stable and long lasting (holds larger volume of copper before saturation) chemical for removal of .3 micron of copper. Microetching following the brushing has the effect of:

- Reduced reflections at the surface

The copper surface is left extremely clean and pure

- Any fine copper particles/slivers are removed

The proposed brush microetch system has these benefits/advantages over pumice/quartz powder systems:

- Eliminates clogging of small feedthrough holes with the powder

- Equipment aquisition costs are about half as high

- The service life of the equipment is more then twice as long

- Maintenance requirements are considerably less

- Problems of pumice powder effecting adjacent process areas is eliminated

- Fresh water requirements are approximately half as high

With the addition of the Puromat fine copper filtration system water in the scrub section can be closed-looped. The optional ROTREG copper recovery system will remove copper from the microetch solution extending bath life considerably. The combination of the two systems will lower costs of disposal greatly.

Furthermore, a brushing machine in the configuration shown is universally applicable, where as other deburring and cleaning work can be carried out with this machine. For small and medium sized circuit manufacturing companies, this can mean that only one machine may be required, providing the capacity of the machine is large enough. Never the less the system is universal enough to adapt to alternate requirements at any size shop.

Following is a drawing of the proposed scrub – microetch system along with SEM photographs of the surface after brushing and after brushing and microetch.

U 60I scrub - microetch system with optional Puomat E and Rotreg regeneration

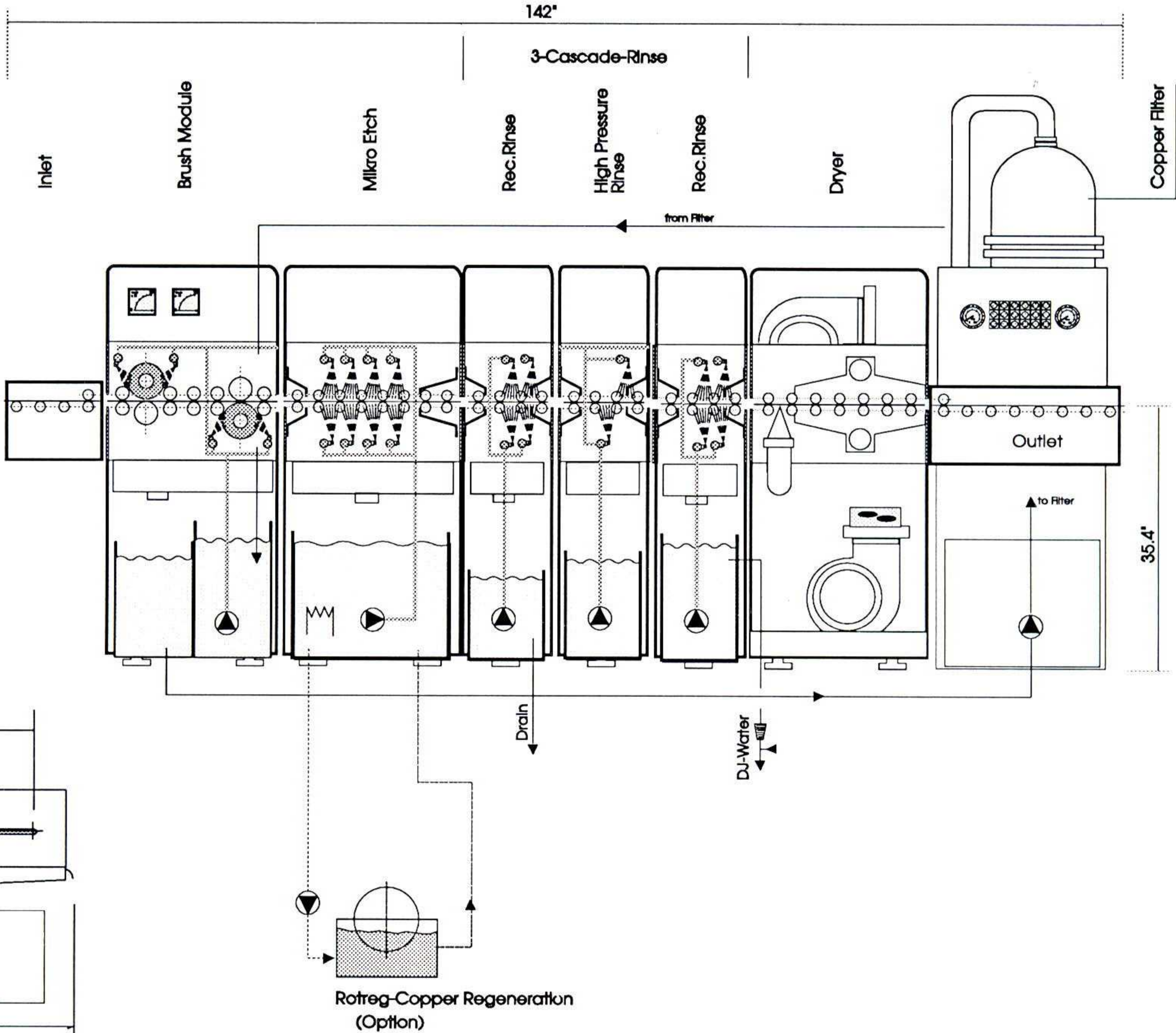

SCRUBBED WITH "ULTRA FINE" COMPOSITE WHEELS AND MICRO ETCHED

200X

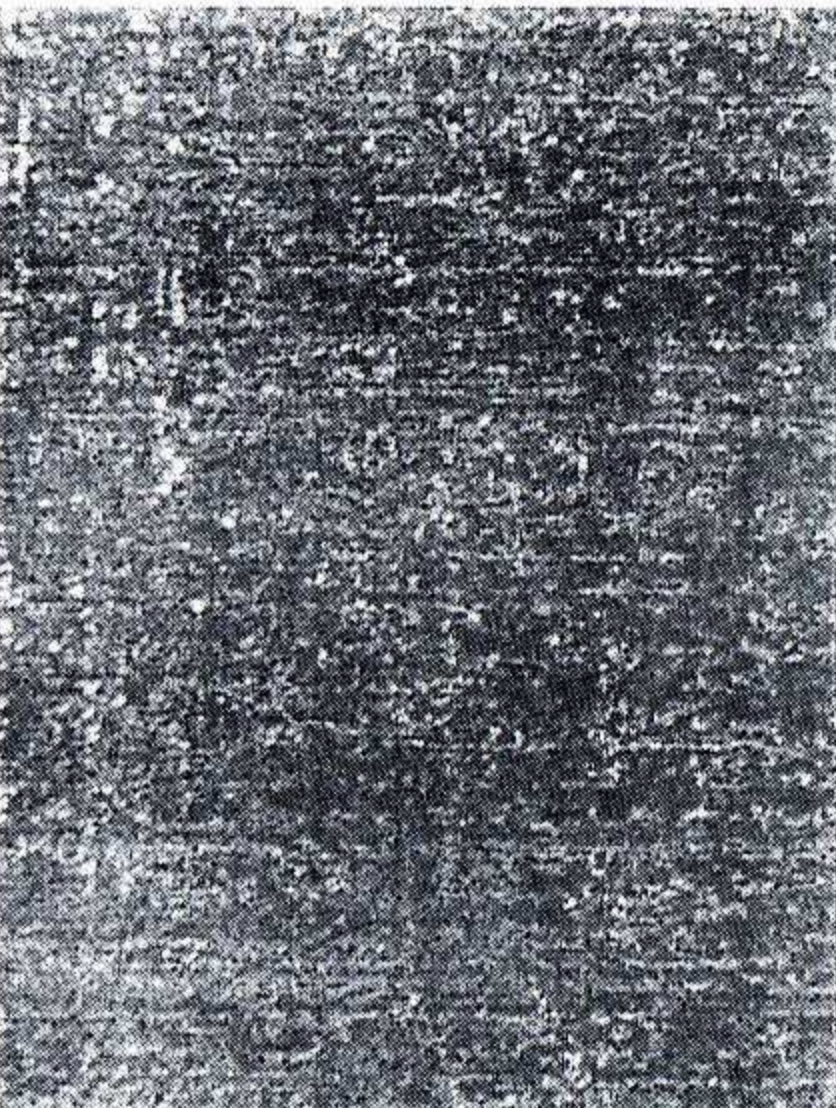

50X

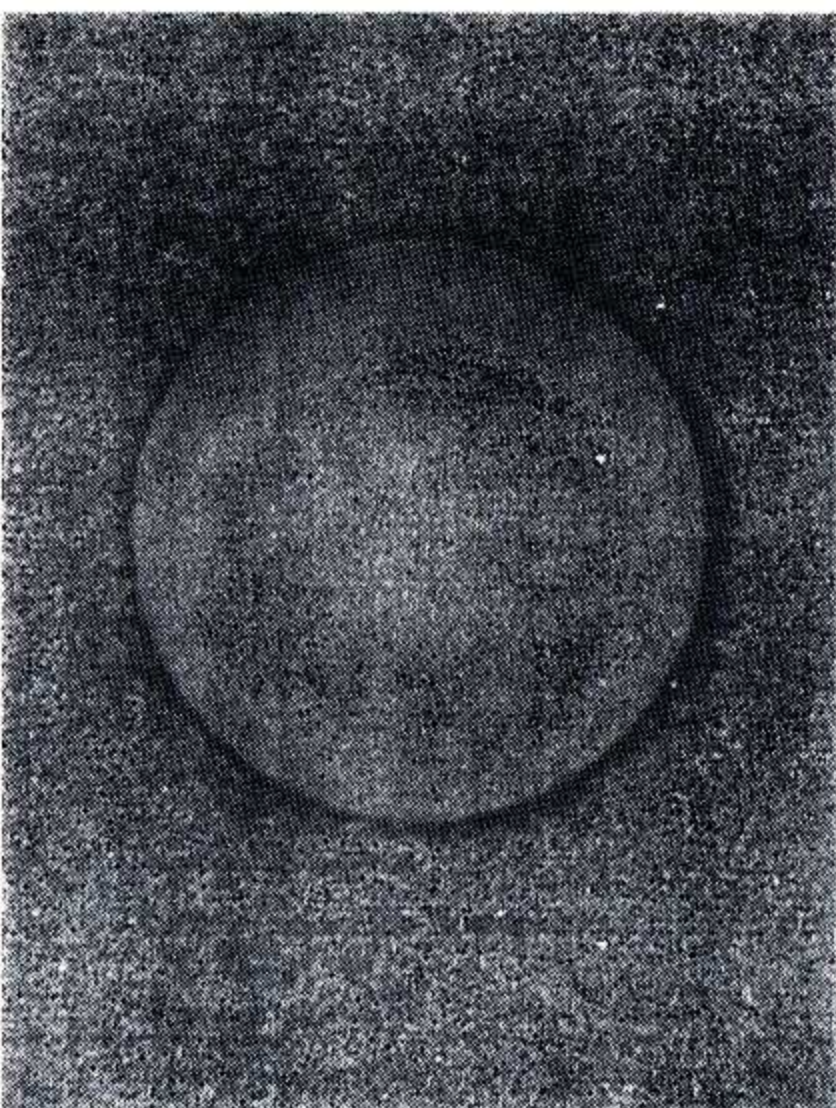

SCRUBBED WITH "ULTRA FINE" NON-WOVEN COMPOSITE WHEELS

200X



50X

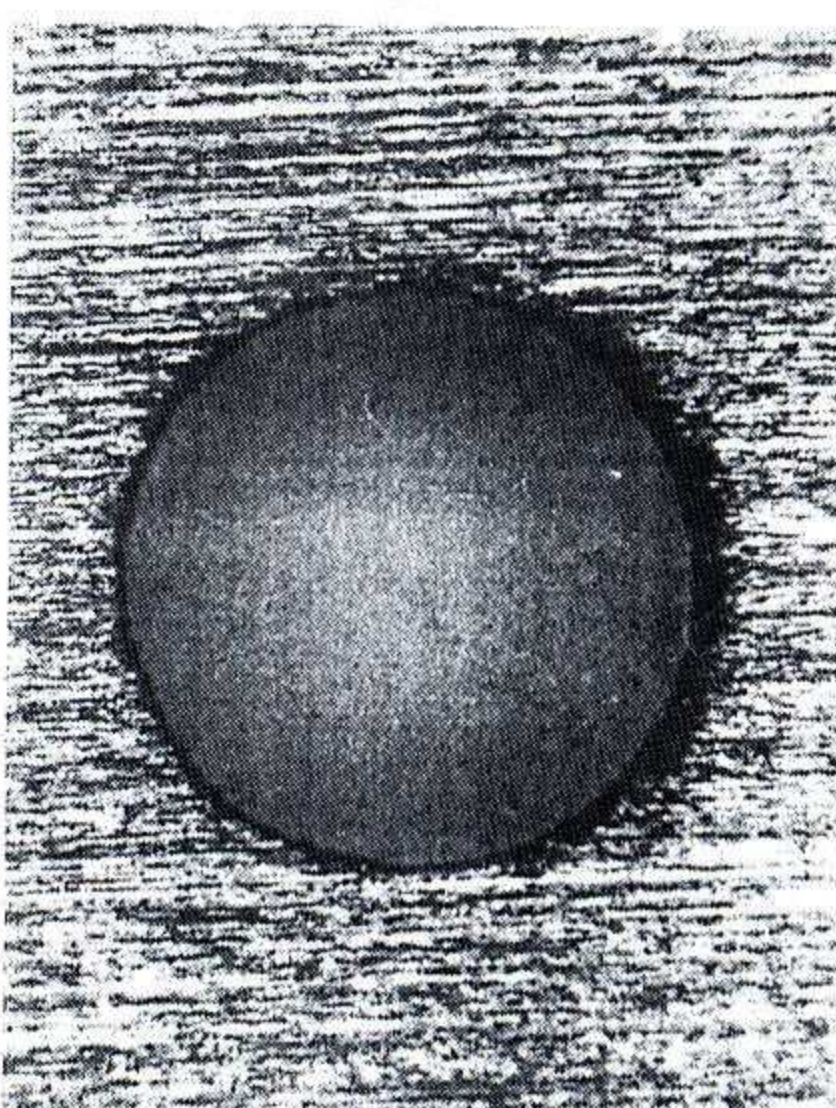



WESERO can match the proper filtration system, or combination of filtration systems to meet your exact requirements.

Water conservation is extremely important due to rising water costs and in following proper environmental practice. WESERO filter systems are designed to provide the maximum performance while saving precious facility space and keeping filter media cost low. For example the Puromat System described on the following page uses only diatomaceous earth as filter media which is very inexpensive.

Following are basic descriptions of the standard filter systems available. Further technical details can be provided upon request.



Wesero Filtration Systems

PUROMAT Fine Copper Filter

Fully automatic diatomite system for closed loop operation - down to 0.5 micron, 1 ppm

Candle Cartridge Filters

5 micron and above fineness, 2.5" dia., 30" len.
Available in 3 or 6 candle units

Bag Filtration Systems

10 micron and above, polypropylene or polyethylene material, single and double bag units available, automatic or manual valves on double units, systems for resist filtration

Automatic Band Filters

Continuous web mesh filtration in a variety of micron sizes and capacities

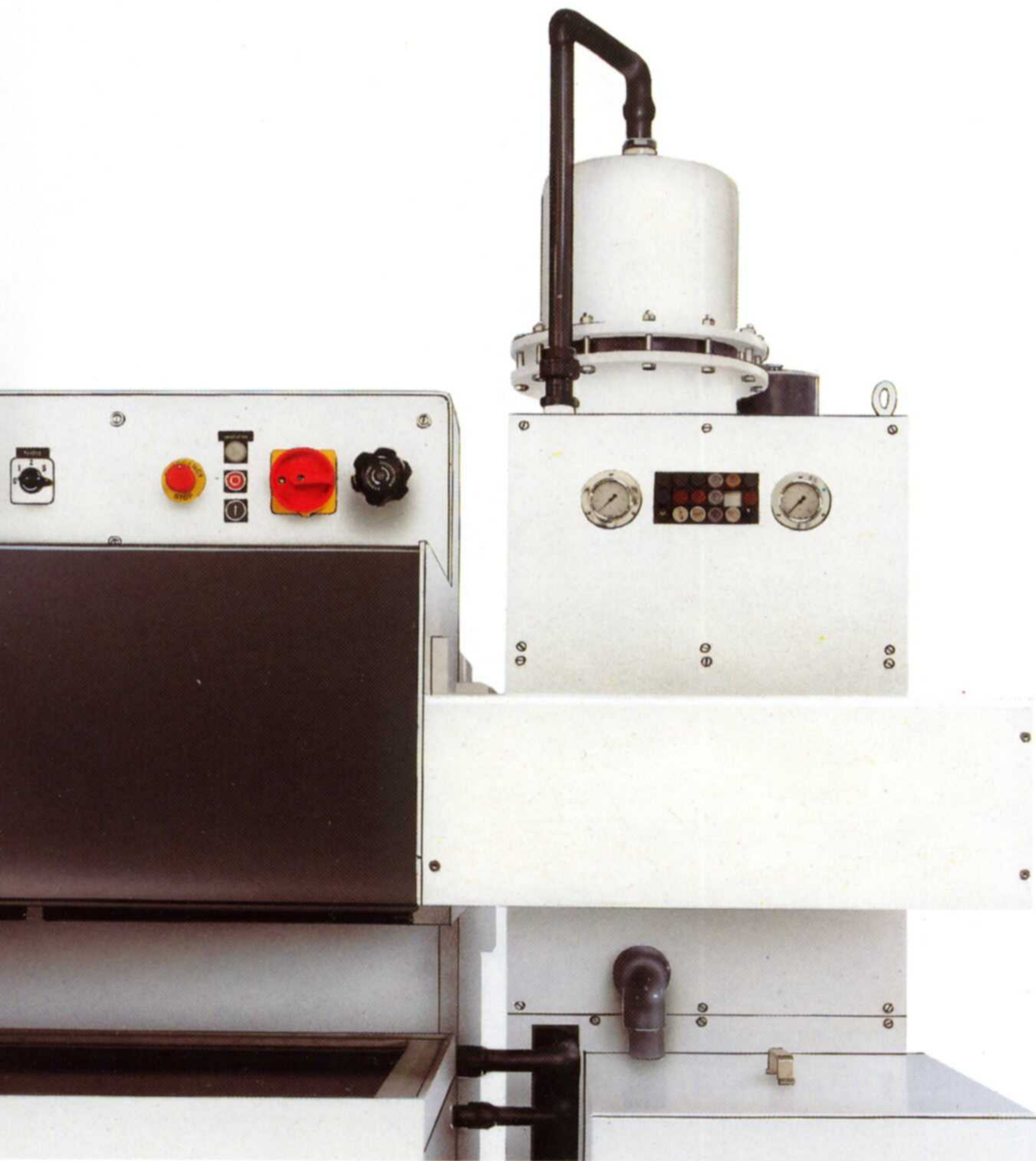

Environmental protection:

with our fine copper filter, „Puomat“ we achieve almost 100 percent reclamation and recirculation of the water. Filtration effectiveness down to 0.5 micron. Metallic copper in circulation max. 1 ppm (1 mg/l).

Throughput quantity dependent upon size of plant: between 15.8 gpm (50 l/min.) and 106 gpm (500 l/min.).

Standard size Puomat filter up to model 100 fully integrated into the brushing machine system without the necessity of a separate location.

Controls are fully Automatic.

Puomat fine copper filter

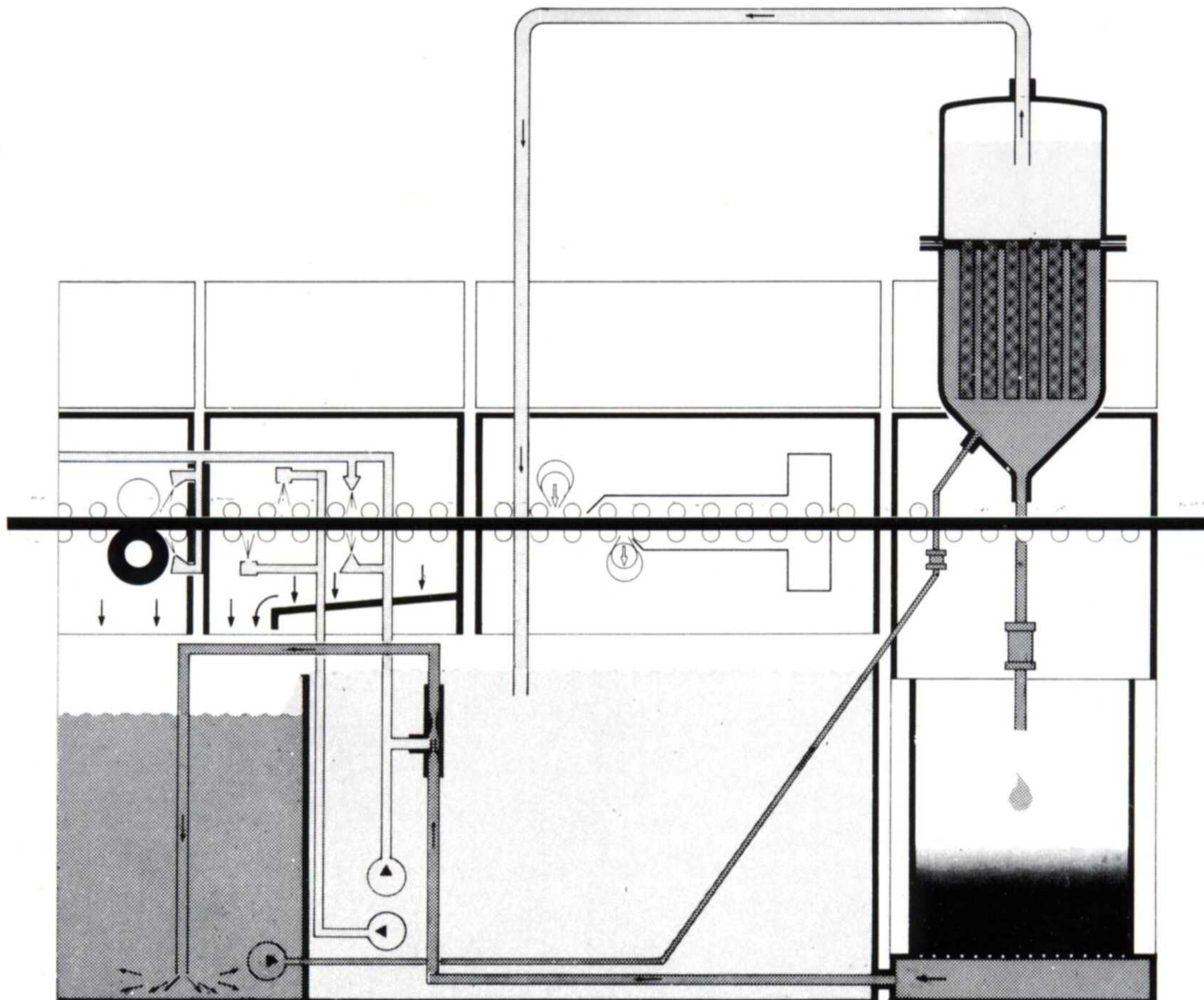

Technical Data

MODEL	UNIVERSAL MODELS		COMPACT - ECONOMICAL JUNIOR MODELS		
	U 60I	U 75I	U 600 JUNIOR	JR. I & 2	JR. I -FB
Working Width Number of brushes	600 mm/24" IT/IB	750 mm/30" IT/IB	600 mm/42" IT/IB	450 mm/18" JR 1 = IT JR 2 = IT/IB	255 mm/10" * IT
Billy roller type diameter	Ceramic 81 mm/3.2"	Ceramic 81 mm/3.2"	Ceramic 61 mm/2.4"	SSTL-Rubber 61 mm/2.4"	SSTL below rubber belt
Brush Arm Bearing type	Cantilever Hydrodynamic	Cantilever Hydrodynamic	Cantilever Sealed needle	Cantilever Sealed needle	Cantilever Sealed needle
Brush size ID -OD -Length	50 -125 -600 mm 2 -5 -24 inch	50 -125 -750 mm 2 -5 -30 inch	50 -125 -600 mm 2 -5 -24 inch	50 -125 -450 mm 2 -5 -18 inch	50 -125 -250 mm 2 -5 -10 inch
Minimum Panel Length mm/inch	150/6	150/6	150/6	150/6	51/2
Panel thickness range	.13 -4.75 mm .005 - .187 in. (.003" core)	.13 -4.75 mm .005 - .187 in. (.003" core)	.26 -4.75 mm .010 - .187 in. Optional .18 - 4.75 mm, .007 - .18	.26 -4.75 mm .010 - .187 in.	.025 - 4.75 mm .001 - .187 in. (Flexible)
Overall Dim. L x W x H Std. System	2182 x 1550 x 1360 86 x 61 x 53.5"	2182 x 1700 x 1360 86 x 67 x 53.5"	2490 x 1550 x 1360 98 x 61 x 53.5"	JR I: 1310 x 1070 x 1405 51.5 x 42 x 55" JR 2: 1560 x 1070 x 1405 61.5 x 42 x 55"	1170 x 1049 x 1405 46 x 41.3 x 55"

* JR I-FB-custom widths up to 600 mm/24" available.

Conveyor speed -DC infinite control, 0 -15 FPM (0 -4.6 meters/min.) standard.

Electrical available: 220/380, 3 ph, 50 Hz or 208/230/460, 3 ph, 60 Hz.

Model Universal 1000 available, 40" (1000 mm) width. Detailed specifications available upon request.

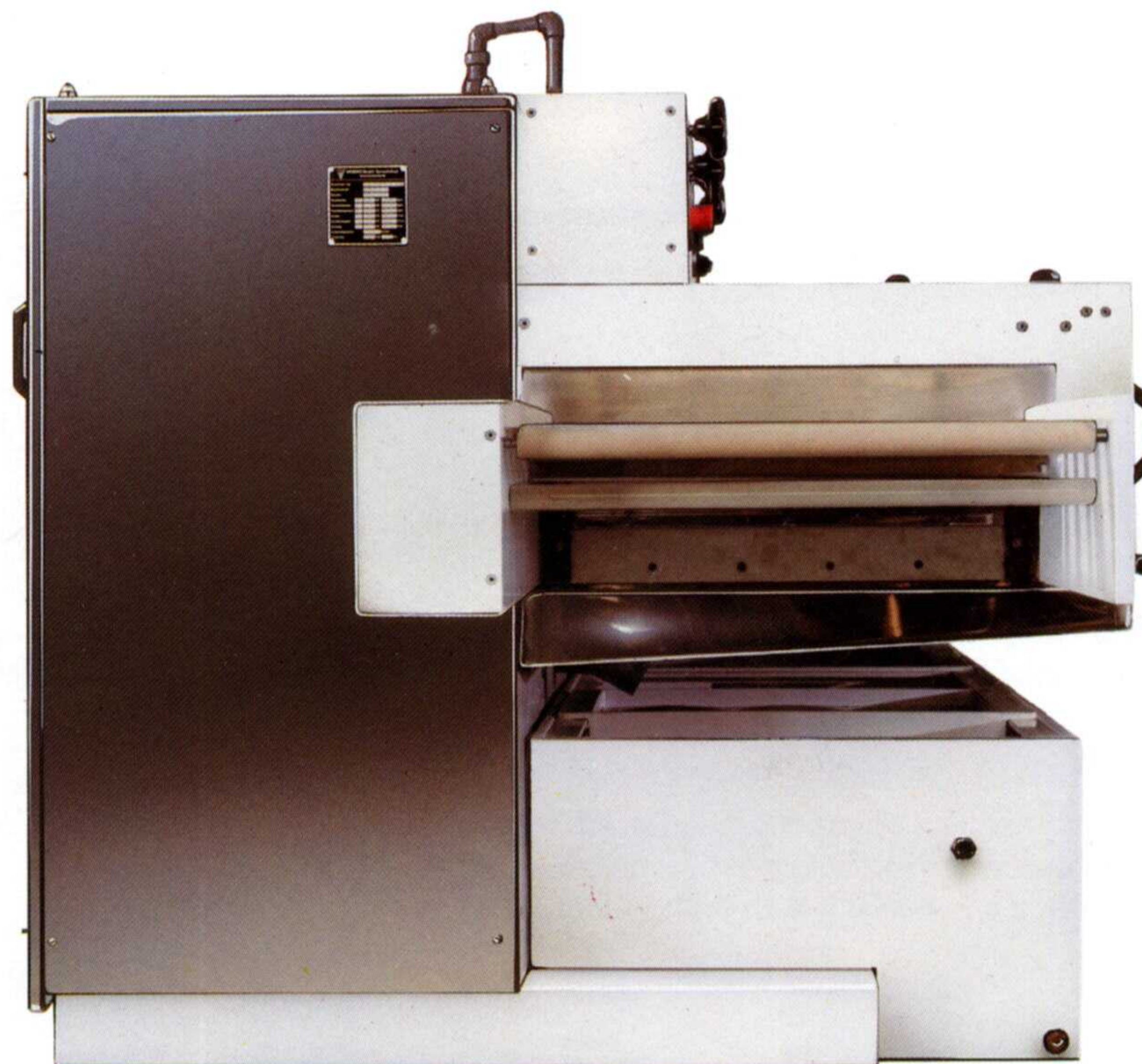

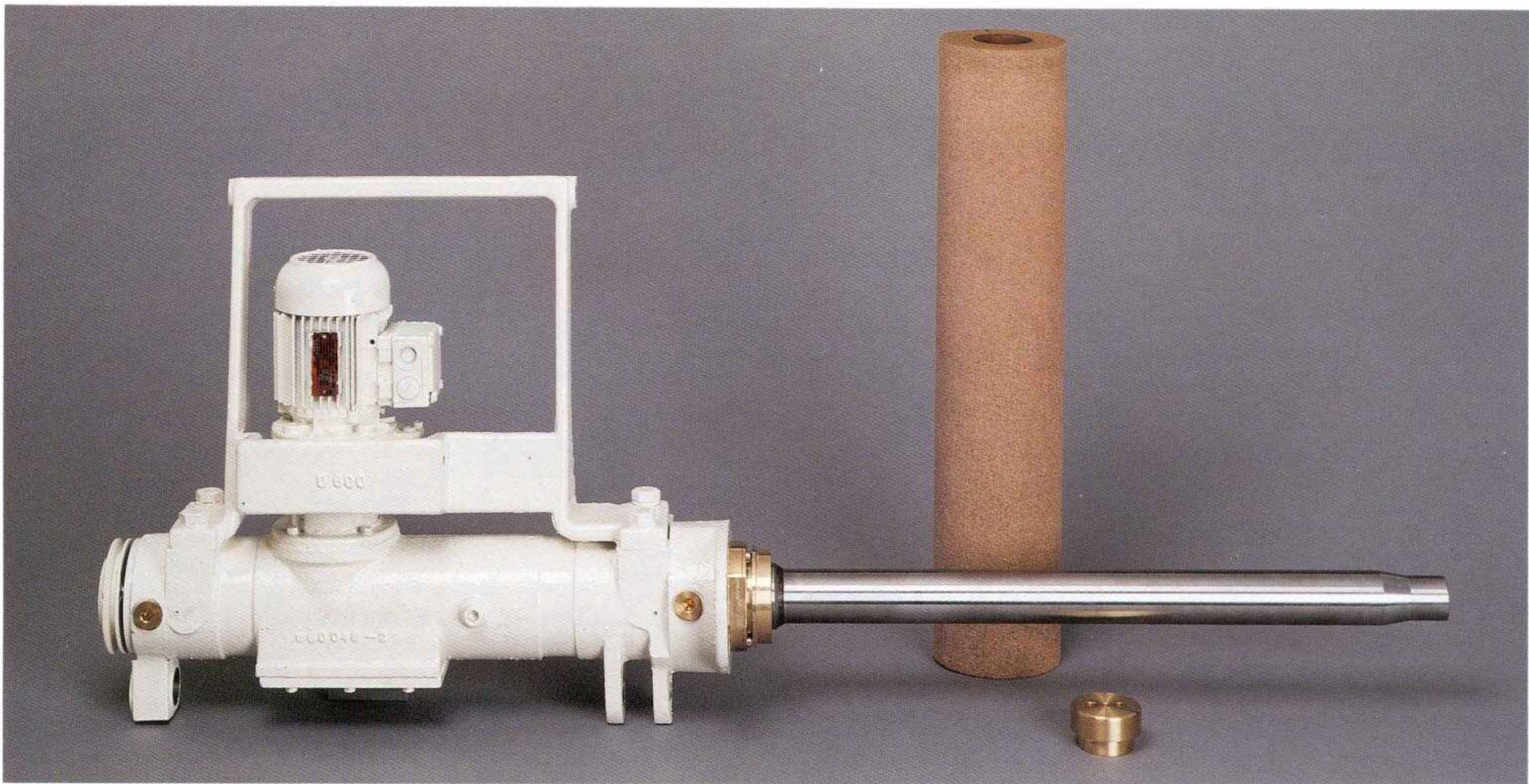

Cantilevered mainshaft construction

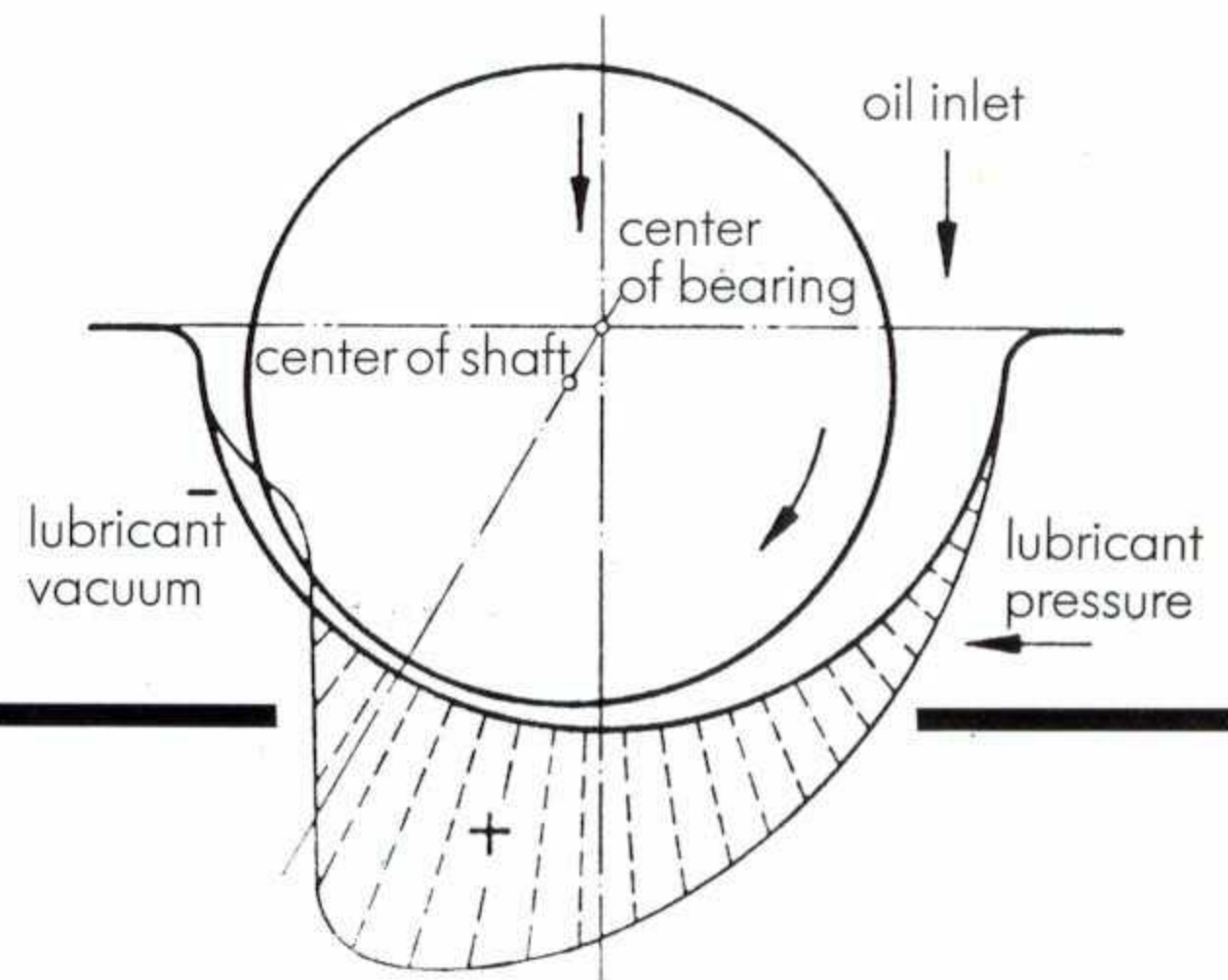

Cantilevered double-bearing supported brush shaft

The Compact Universal 60I with hydrodynamic oil-lubricated plane bearings (patent 2712921.I/14). This brush shaft assembly, which incorporates an integrated, encapsulated, oscillation mechanism with geared-motor drive, is completely maintenance-free. Full 10 years warranty. The function of the plane bearings is on the principle of hydrodynamic lubrication.

The rotation of the shaft within the housing produces a forced feed of oil from the shaft housing clearance. The liquid pressure generated between moving surfaces within the bearings is such that even under

heavy external loads the oil film is maintained preventing metal-to-metal contact within the bearing whilst at the same time ensuring rotational concentricity. The operating effectiveness and the long working life of our brush shaft system are the result of the design of this principle.

With this exemplary technique, Wesero places at the disposal of circuit-board manufacturers an example of the highest technology available to the industry.

Junior Models Compact/Economical non-modular Systems



WESERO offers a full line of JUNIOR MODELS to meet the requirements of varying processes at an economical cost.

Junior I-FB

The Model Junior I-FB (Flat Belt) system is ideally suited for cleaning small parts such as: wafers, ceramic substrates, glass plates, small metal parts of circuit boards and flexible circuits.

The system consists of: Input, Brush section with one 5" OD top brush against a flat rubber belt, rinse and heated dry with output. Main features are: Stainless steel and heavy duty polymer main construction with steel support legs, cantilever brush arm with sealed needle bearings and Selectable rotation and oscillation. Optionally a 115 PSI high pressure rinse can be added and/or chemical rinses/water rinses can be added prior to brush section to meet process requirements.

The system transports 2 x 2" (51 x 51 mm) parts and .001" (.025 mm) thick flexible material.

Junior I & 2

The Junior I & 2 Models are 18" (450 mm) wide systems for use in special process applications, R & D areas, quick turnaround areas and small to medium production areas.

The systems consists of: Input, Brush section, rinse, and heated dry with output. The JR. 1 has one 5" (125 mm) OD top brush and the JR. 2 has one T/B 5" (125 mm)

OD brush against 2.4" (61 mm) SSTL rubber coated billy roller. See inside Technical Data section for further details.

Junior U 600

The Junior 600 is compact and non-modular, yet is a fully functional process unit that is ideally suited for low to medium production volumes at economical pricing. Processes panels up to 24" (600 mm) wide.

The system consists of: Input, brush section with IT/B 5 (125 mm) OD brush against 2.4" (61 mm) diameter ceramic coated billy rollers, rinse, and heated dryer with output. The cantilever brush shaft utilizes sealed needle bearings and has Selectable rotation and oscillation. Options available are: Thin material conveyor to .005" (.127 mm) core, extended length dryer and various filter options.

The Junior Models can be very beneficial for use in special process applications, where space constraints exist and for full production areas where throughput does not require the heavy duty-modular Universal 601/751 systems.

See inside Technical Data sheet for further details. A specific data sheet on each product is available upon request.

Specifications subjects to change without notice.

Local Area Representative:

